

Vacuum Lifters

(Suction Discs)

40°

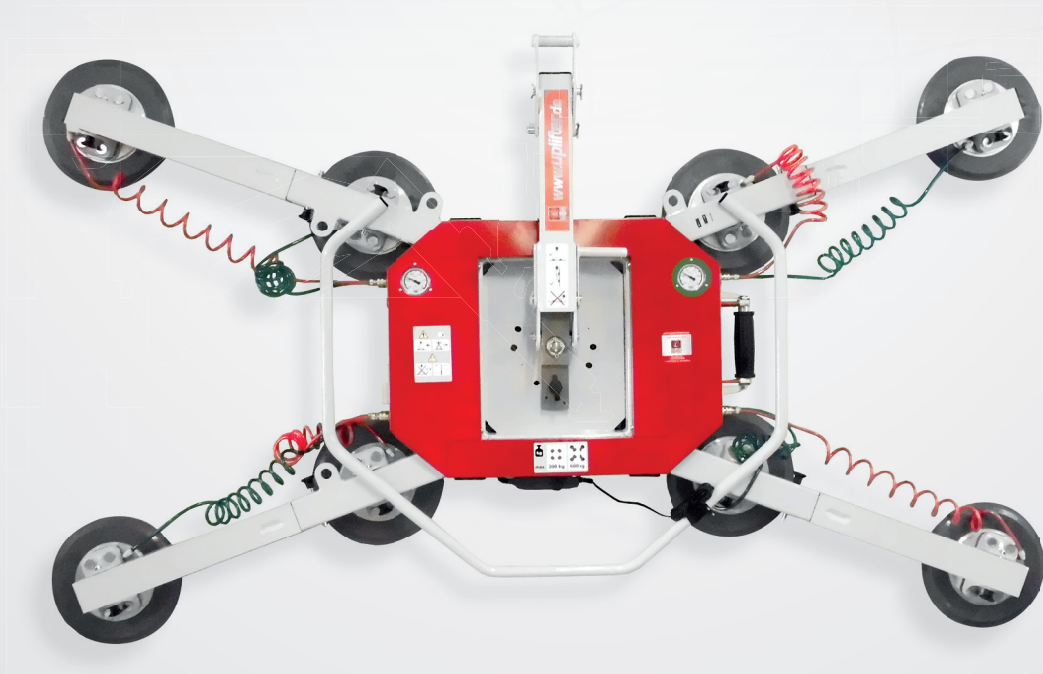
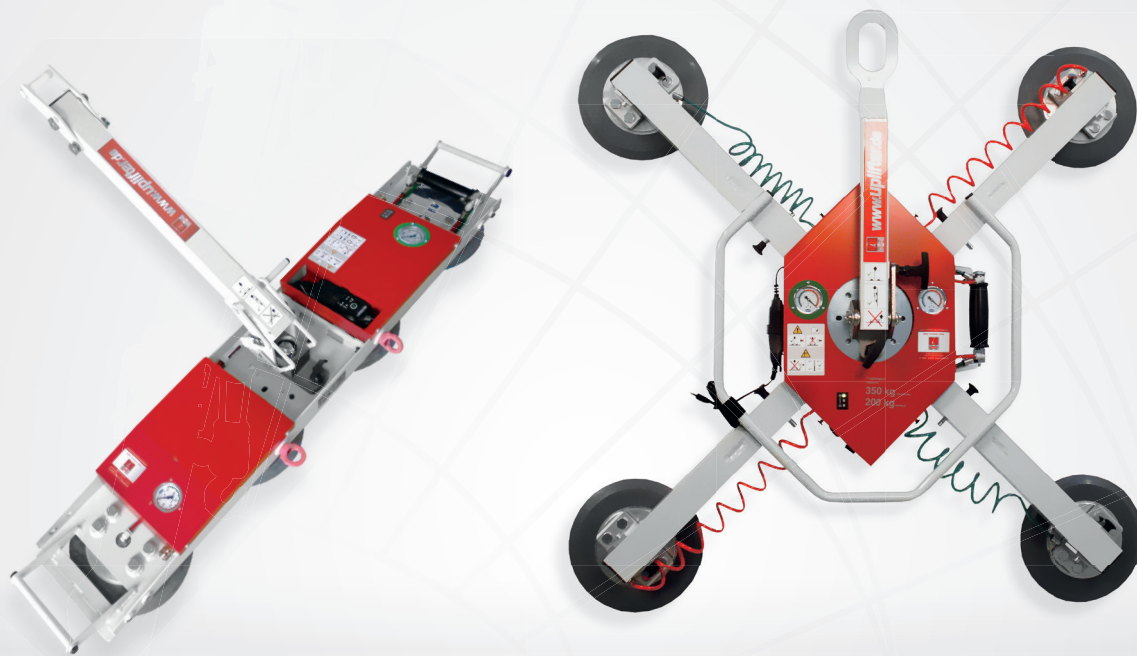

Vacuum Lifting

TCA Lifting Ltd
Unit 4, Derby Dell Buildings, Lasham
Hampshire. GU34 5RX United Kingdom
Tel. (+44) 0845 603 5360
info@tcalifting.com
www.tcalifting.com



More information: www.tcalifting.com

Suction Disc UPG 350-2

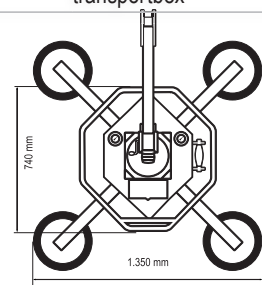
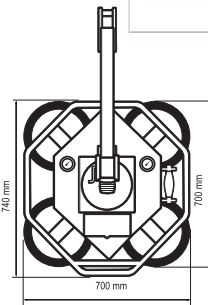
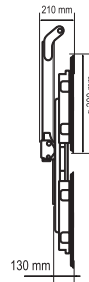
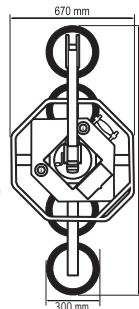
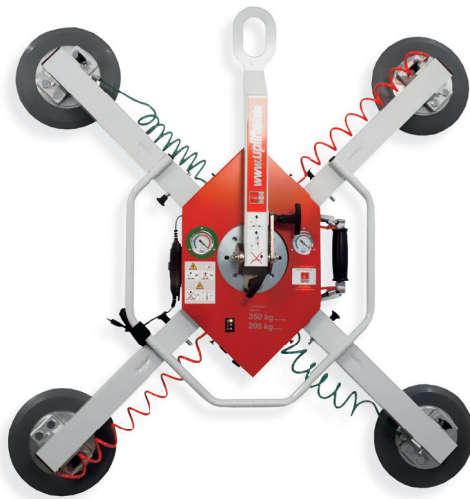

Technical Data

Vacuum System	2-circuit-system
Lifting Capacity	up to 350 kg
Vacuum Cups	4
Tare Weight	43 kg
Height	min. 210 mm
Operating Temperature	0 up to 40°C
Operating Time	8 hours
Accessory	incl. wooden transportbox

Features

- » Manual tilting 90°
- » Manual turning 360°
- » Silicon-free vacuum cups (Ø 300mm)
- » Off-grid Motor with 12 volt rechargeable battery
- » Integrated vacuum-reserve tank
- » Individual Arrangement of the spring mounted vacuum Cups
- » Vacuum Cups adjustable without tools
- » DIN 13155
- » Optic/acoustic warning devices (low Vacuum warning buzzer)

Suction Disc UPG 450

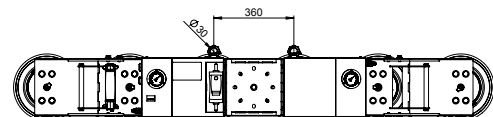
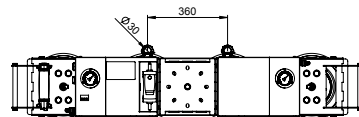
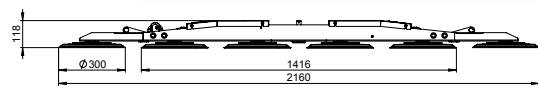
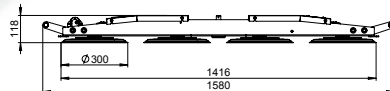
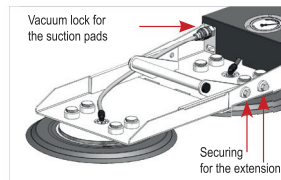
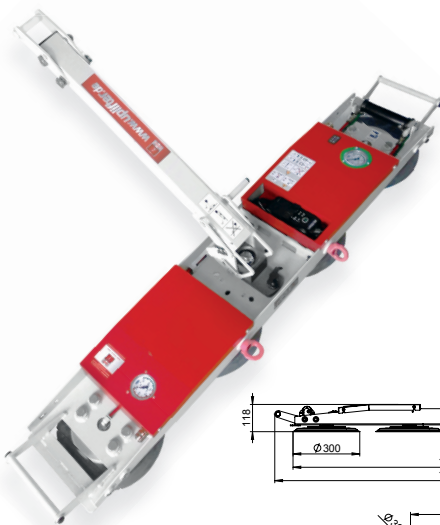

Technical Data

Vacuum System	2-circuit-system
Lifting Capacity	up to 450 kg
Vacuum Cups	4 / 6
Tare Weight	47 kg / 57 kg
Height	min. 118 mm without load-arm min. 179 mm with load-arm
Operating Temperature	0 up to 40°C
Operating Time	8 hours
Accessory	incl. wooden transportbox
Highlight	removable load-arm

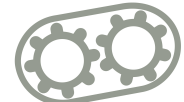

Suction Disc UPG 600-2

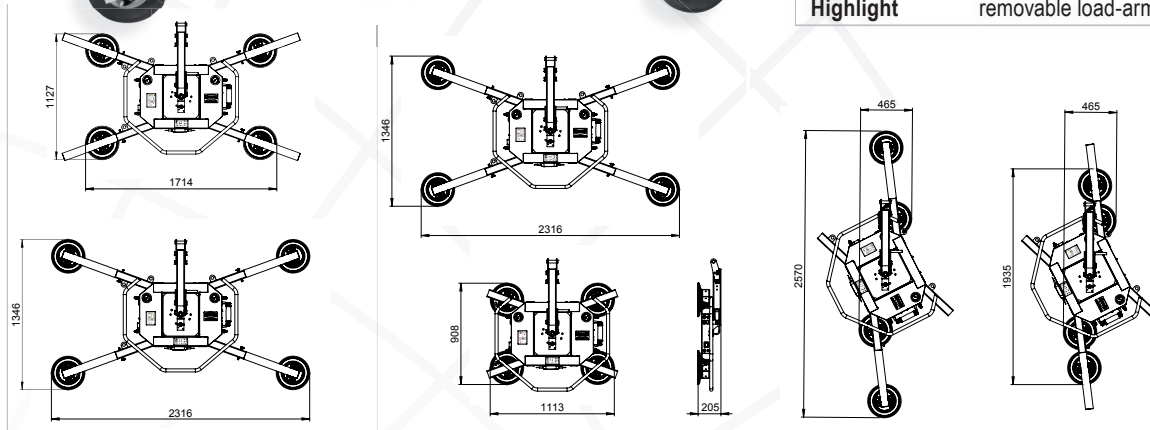
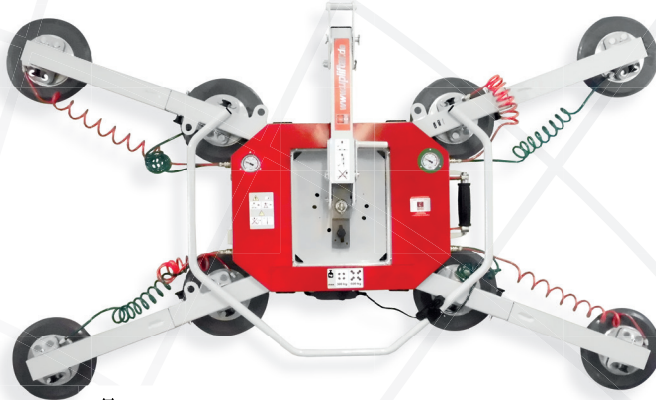

Technical Data	
Vacuum System	2-circuit-system
Lifting Capacity	up to 600 kg
Vacuum Cups	4 / 6 / 8
Tare Weight	70 kg / 80 kg / 89 kg
Height	min. 139 mm without load-arm min. 205 mm with load-arm
Operating Temperature	0 up to 40°C
Operating Time	8 hours
Accessory	incl. wooden transportbox
Highlight	removable load-arm

Features

- » Manual tilting 90°
- » Manual turning 360°
- » Silicon-free vacuum cups (Ø 300mm)
- » Off-grid Motor with 12 volt rechargeable battery
- » Integrated vacuum-reserve tank
- » Individual Arrangement of the spring mounted vacuum Cups
- » Vacuum Cups adjustable without tools
- » DIN 13155
- » Optic/acoustic warning devices (low Vacuum warning buzzer)

Equipment



- » Foam-rubber vacuum cups



- » UPT 200

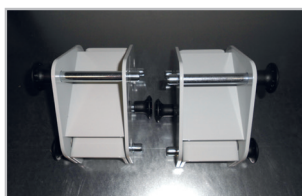

- » Mount Extensions

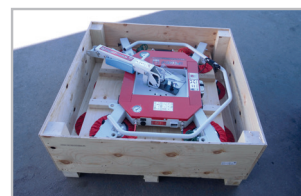

- » Wooden Transportbox

Your contact person:

TCA Lifting Ltd
Unit 4, Derby Dell Buildings, Lasham
Hampshire. GU34 5RX United Kingdom
Tel. (+44) 0845 603 5360
info@tcalifting.com
www.tcalifting.com

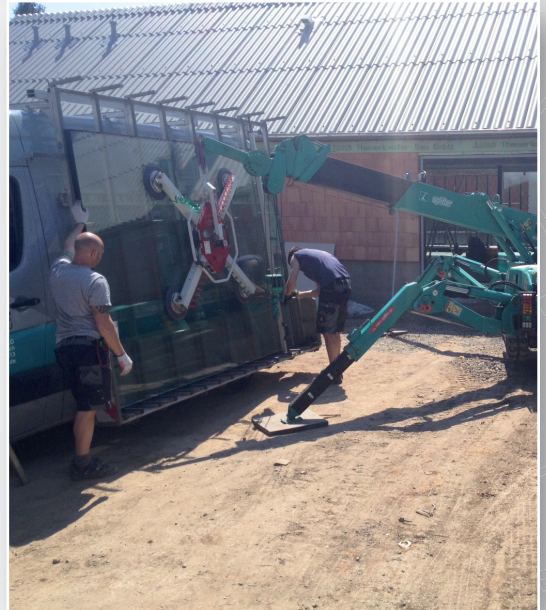

TCA Lifting Ltd
Unit 4, Derby Dell Buildings, Lasham
Hampshire. GU34 5RX United Kingdom
Tel. (+44) 0845 603 5360
info@tcalifting.com
www.tcalifting.com

